

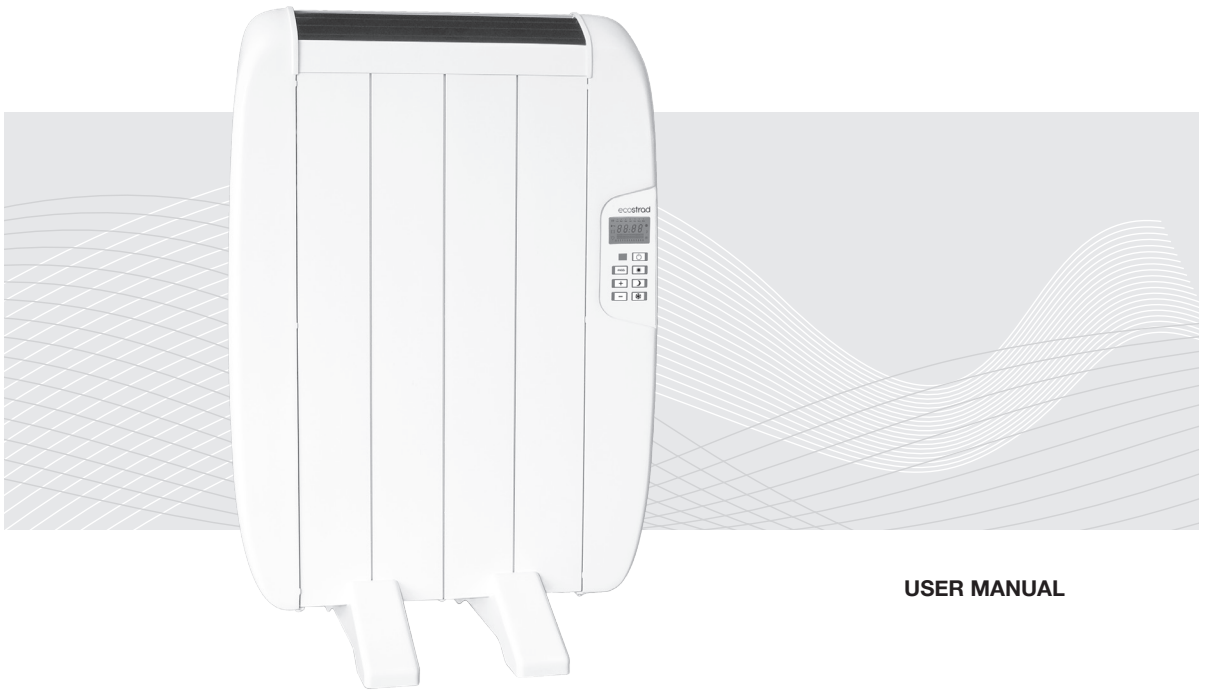

ecostrad

eco+



USER MANUAL





Thank you for choosing ecostrad radiators

When installed and programmed in accordance with these instructions the new generation of ecostrad electric radiators will provide exceptional comfort and energy savings.

Index

1. Safety Notes	3
2. Introduction for installation	4
2.1 Important	4
2.2 Safety measures	4
2.3 Installation on the wall	5
2.4 Installation of the feet	10
3. Operation	10
Control panel	10
LCD Screen	11
Operating modes	12
3.1 Standby	12
3.2 Manual mode	12
3.2.1 Comfort mode	12
3.2.2 Economy mode	13
3.2.3 Anti-frost mode	14
3.3 Programming mode	14
3.3.1 Time schedules	14
3.3.2 To set the time	14
4. “Open Windows” Function	18
5. “Lock” Function	19
6. Power cuts	19
7. Maintenance	19







Where you see this symbol on any of our electrical products or packaging, it indicates that the relevant electrical product should not be disposed of as general household waste in Europe. To ensure the correct waste treatment of the product, please dispose of it in accordance with any applicable local laws or requirements for disposal of electrical equipment. In so doing, you will help to conserve natural resources and improve standards of environmental protection in treatment and disposal of electrical waste.



1

Safety Notes

- **Please read these instructions carefully.**
- To disconnect mains power from the radiator remove the plug from the wall socket, but never pull on the cable.
- Do not leave the mains cable in contact with the radiator when it is switched on.
- During operation, the radiator must be kept well away from combustible materials, such as curtains, carpets and furniture etc.
-  **WARNING: In order to avoid overheating, do not cover the radiator.** 
-  **WARNING:** If the mains power cable is damaged, it must be replaced by the manufacturer, its after-sales service or similarly qualified persons, in order to prevent any danger.
-  **WARNING:** Do not use this radiator in the immediate surroundings of a bath, a shower or a swimming pool.
- The radiator must not be installed below or in front of a mains socket.
- This product must not be used in bathrooms.
- When the radiator is disposed of, the requirements established by current legislation on waste processing and recycling must be taken into account.
- The installation should be carried out with consideration to the manufacturer's instructions and in accordance to the relevant National Wiring Regulations BS7671.
- It is very important that the radiator has a good Electric Earth connection.
- The radiator should be installed so that its mains plug is always accessible.
- This radiator cannot be flush-mounted with a wall. Safety distances should always be respected.
- The radiator is fitted with a block so that children cannot change the programming.
- This unit is not designed to be handled by persons (including children) with physical, sensory or mental handicaps, with little experience or knowledge, unless they are under the supervision of an adult responsible for their safety with the instructions on its use. Children must always be supervised to ensure they do not play with the unit.
- Children under three should be kept well away from the heater unless they are continually supervised.
- Children between three and eight should only switch the unit off or on, providing it is positioned or installed in its final operating location, and be supervised or have received instructions on how to use the unit in a safe manner and understand the risks involved.
- Children between three and eight must not plug in, adjust or clean the heater or carry out any maintenance operations.
- This appliance can be used by children aged from 8 years and above



and by persons with reduced physical, sensory or mental capabilities or lack of experience and knowledge if they have been given supervision or instruction concerning use of the appliance in a safe way and understand the hazards involved.

- Children shall not play with the appliance.
- Cleaning and user maintenance shall not be made by children without supervision.
- **⚠ WARNING: Certain parts of this product can become very hot and cause burns.** Special attention should be paid when children and other vulnerable persons are present.
- **⚠ CAUTION: Keep bags and other accessories well away from children.**
- Do not touch the external parts of the radiator when it is operating.
- It is quite normal that, with the first switch-on, the unit produces a 'new' smell. Allow your heater to operate in a well-ventilated place for two or three hours.
- Before the first switch-on for the winter or when the heater has not been used for several days, the unit should be cleaned (follow the steps given in the 'maintenance section'). This cleaning operation will avoid burning accumulated dust and other debris.
- This radiator can not be operated with external programmable controllers or any other external control device.
- The convection effect, together with other ambient factors, can cause discolouration to metal surfaces and plastics.
- Do not use your radiator without first fitting the base plinths directly on the floor.
- Temperature differences can cause crackling and other noises in the unit. This does not indicate any failure in the radiator.
- The warranty for the radiator does not cover any damage caused by failing to read these instructions.

2 Instructions for installation

2.1 Important



- The radiator must never be installed just below a mains socket.
- This radiator can be installed on feet (provided) or on a wall.
- The radiator must never be installed in a position where the switches and other controls can be reached by someone in the bath or shower.

2.2 Safety measures



- The radiator works through natural air convection. In order to achieve correct performance and uniform heat distribution, when it is installed on a wall the lower part of the radiator must be at a minimum distance of twenty centimetres from the floor and a minimum distance of twenty centimetres from the sides and fifty centimetres from an upper shelf and also a minimum distance of twenty centimetres from any wall or object (furniture and curtains, etc.).

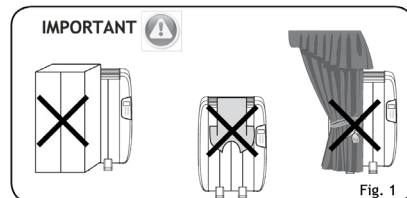



2.3 Installation on the wall

It is vital that the radiator is affixed firmly to a solidly constructed and levelled wall.

Make sure that an electrical socket is near where you intend to position the radiator.

Once fixed to the wall it is important to check and ensure the security of the brackets to support the weight of the radiator.

1

Select a suitable location on the wall, which should be firm and level. Check that there is a mains socket close by.

2

Open the package box and check that all accessories are present.

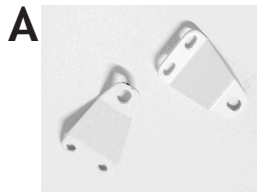

1 or 2 parts, according to model

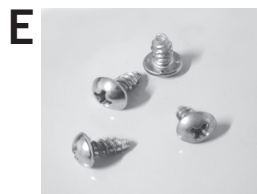
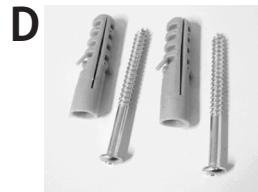

Feet

Fig. 2



Safety and installation distances

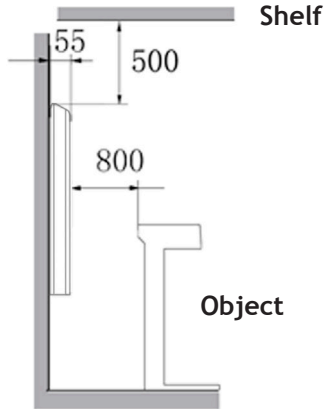

Distances
in mm

Fig. 3

3

The distances marked, "a" and "e" vary depending on the model.

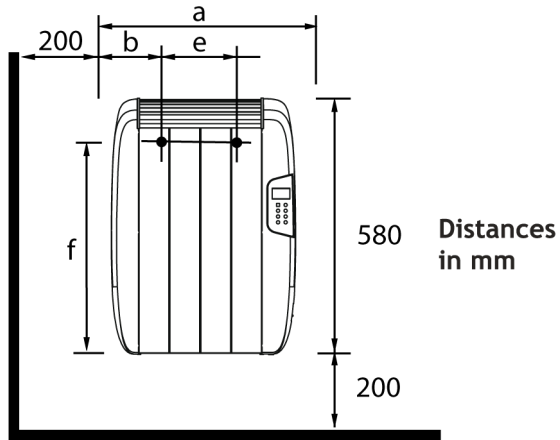

Distances
in mm

Models	a (mm)	b (mm)	e (mm)	f (mm)
ECO6+	417	132	140	458
ECO9+	557	132	280	458
ECO12+	697	132	420	458
ECO15+	837	132	560	458
ECO18+	907	132	630	458

Fig. 4



- 4** While respecting the previously indicated safety measurements, make two marks on the wall according to measurement “e” indicated in figure 4 and at a height of 695 mm from the floor (not the skirting board).

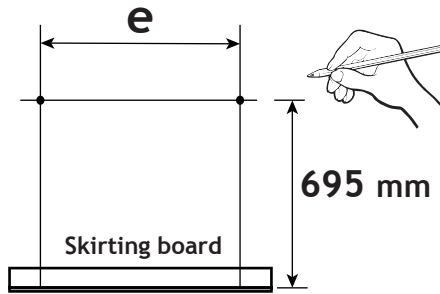

Fig. 5

- 5** Drill two 10 mm diameter holes, with a minimum length of 60 mm at the wall marks.

- 6** Screw the hooks (C) into the two holes, with the two screws and two plugs (D).

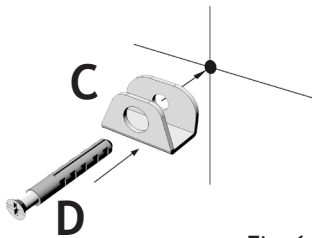

Fig. 6

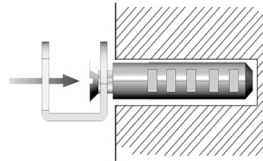

Fig. 7



7

Screw the two brackets (A) (or one support, depending on model) to the rear part of the heater with the four screws (E) (or two screws, depending on model).

Note: The two brackets (A) are screwed to the holes located on the lower rear part, at both ends.

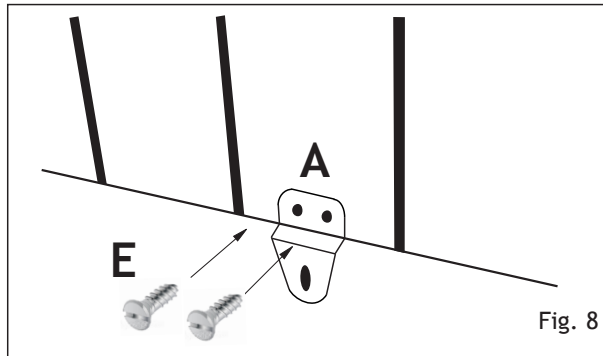

8

Hang the radiator on the two hooks (C) on the wall.

Ensure that the radiator is correctly secured on both hooks.

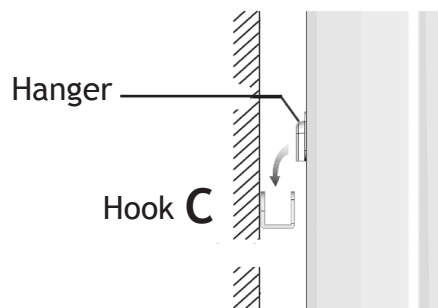



9

When the radiator is fitted in place, make one or two marks on the wall, according to the model, at the one or two brackets (A) to ensure the radiator is fixed to the wall:

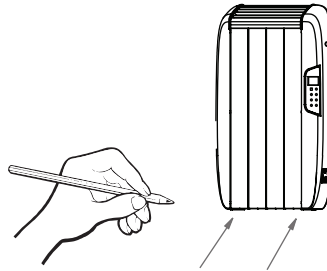

Fig. 10

10

Drill two 4 mm diameter holes, with a minimum depth of 25 mm at the two marks on the wall.

11

Use one or two screws and one or two plugs (B), according to the model, to completely secure the radiator to the wall.

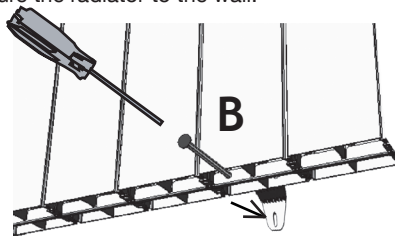

Fig. 11



2.4 Feet installation

Screw the two feet to the lower rear part of the heater with the four screws (F).

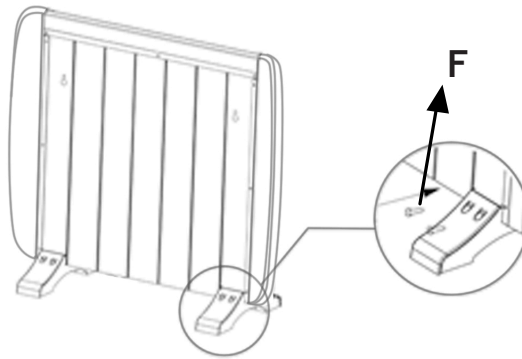

Fig. 12

3 Operation

- Your radiator is fitted with a digital, daily-programmable timer-thermostat that controls and adjusts the heating.
- The radiator can be used either manually or automatically. It is fitted with a daily timer for each day of the week.



IMPORTANT:

The temperature indicated on the screen may differ from that given by another thermometer in the same room.

Different conditions such as air currents, windows etc., could cause these differences.

Control panel

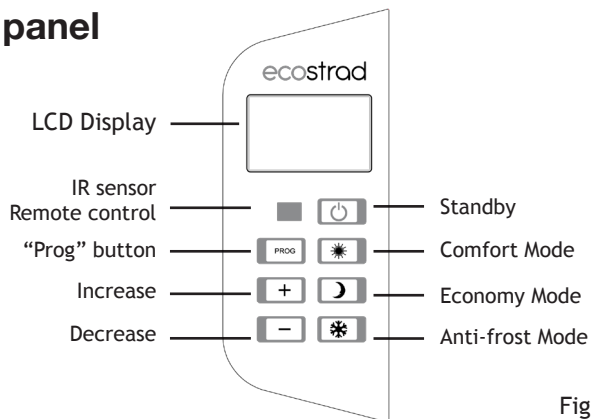

Fig. 13



LCD Screen

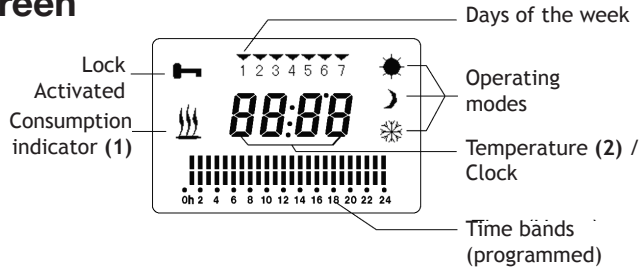

Fig. 14



Notes:

(1) CONSUMPTION INDICATOR:

This appears when the radiator is consuming power, in other words, in operation.

(2) TEMPERATURE INDICATOR:

- Ambient temperature: that of the room, it is displayed on all screens by default.
- Assigned temperature: that selected by the user as the desired temperature for COMFORT MODE, ECONOMY MODE OR ANTI-FROST MODE. To display this temperature press the (-) or (+) button.

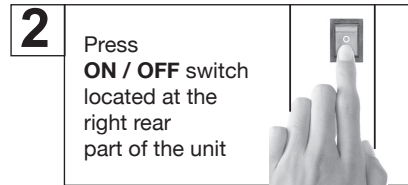
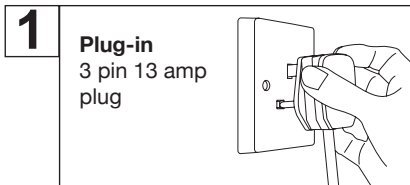

The LCD screen will light up and all the symbols will flash several times.



Then the operating mode just before the last switch-off appears (standby, manual or programming mode), together with the approximate room temperature.



Operating modes

Your radiator incorporates 2 operating modes, manual and programming modes.

3.1 Standby

To switch the radiator on and off press



The radiator comes on and the last selected operating mode symbol appears on the screen. In addition, the approximate room temperature is displayed.

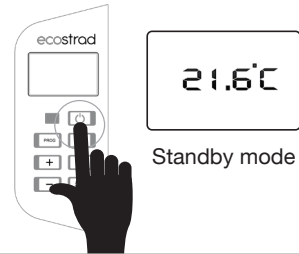

3.2 Manual mode

Press the "PROG" button until the time bands disappear from the LCD screen.



When in manual mode, the desired heating mode can be selected (comfort, economy or anti-freeze) by pressing the corresponding button (Fig. 13) and the radiator will permanently operate in any of these modes with the assigned temperatures.

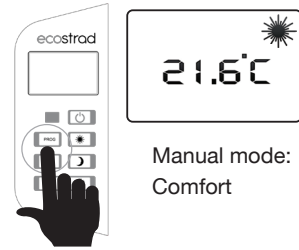

3.2.1 Comfort mode

Press the comfort mode button (sun).





Press either of buttons (+) or (-) repeatedly to change the temperature.

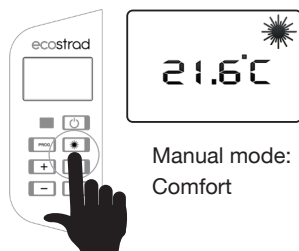

The room temperature will be displayed after a few seconds of the display.

The comfort mode is recommended for a comfortable temperature when remaining in the room.





 Recommended comfort temperature: 20 °C.

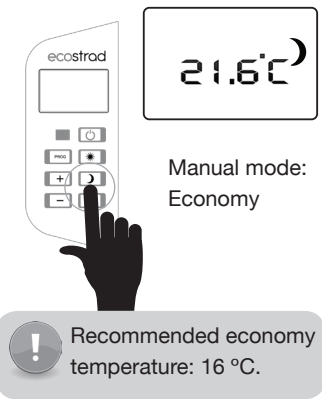

3.2.2 Economy mode

<p>Press the economy mode button (moon).</p> <p>Press either of buttons (+) or (-) repeatedly to change the temperature.</p> <p>The room temperature will be displayed after a few seconds of the display.</p> <p>This mode is recommended for long absences from the room and for setting the night time temperature.</p>	 
--	--

3.2.3 Anti-frost mode

<p>Press the anti-frost mode button (ice).</p> <p>Press either of buttons (+) or (-) repeatedly to change the temperature.</p> <p>The room temperature will be displayed after a few seconds of the display.</p> <p>This mode is recommended for unused dwellings in extremely cold climates.</p>	 
---	---



Heating Element ON Indicator:

When the radiator is operating, pictogram  will be on.

Note: If, no buttons are pressed after approximately ten seconds the screen will be switched off.

It will be switched on again when any button is pressed.



3.3 Programming mode

The radiator is not supplied with the time and date set.

You must adjust the clock for changes between summer and winter times.

3.3.1 Time Schedules

The radiator has **3 possible programs** according to your wishes.

P1 Need to program day by day (Monday to Sunday).

P2 Need to program only Monday, Saturday and Sunday.

Note: Monday to Friday every day the program is the same.

P3 Need to program only Monday.

Note: Monday to Sunday every day the program is the same.

3.3.2 To set the time

1

If the radiator is in Standby, press the "Standby" button to switch it on.

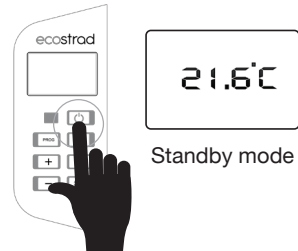

2

Press the "PROG" button for **three seconds**. The four clock digits will be displayed.

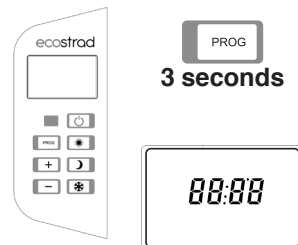



3

First, the two "hour" digits will flash.
Use the (+) or (-) buttons to first change the hour. Confirm the selected hour by pressing the "PROG" button.



4

Repeat this for the minutes.
Press the "PROG" button to confirm

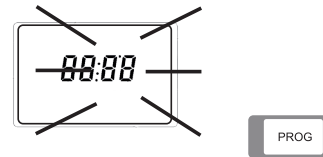

5

Complete the time setting by pressing the (+) and (-) buttons to change the day (1 = Monday, 2 = Tuesday, etc.).

Press the "PROG" button to complete.

Note: After working for two or three months, the clock will usually require adjustment.

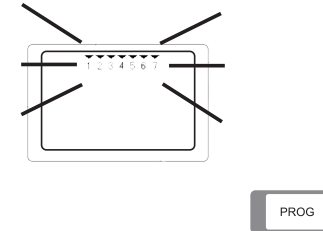

6

Use the (+) or (-) to select one of the three possible programs according to your wishes (P1, P2 and P3). See point 3.3.1, Time Schedules)

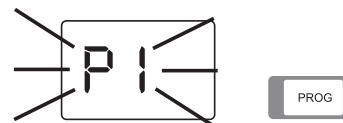



3.3.2 To create a custom program

7

Note bars will be displayed at the bottom of the screen.

Begin to create a custom program by programming the first hour for Monday, 0:00 hours (the first band will flash).

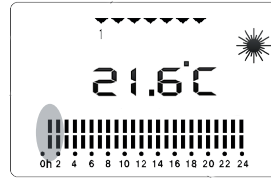

First select your mode setting for 0:00 hours. **Press the comfort, economy, anti-frost or standby buttons in order to select the desired mode.**



COMFORT
button

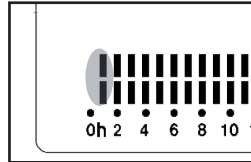

Note **double bar** will be displayed

OR



ECONOMY
button

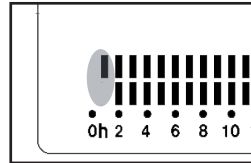

Note **single upper bar** will be displayed

OR



ANTI-FROST
button

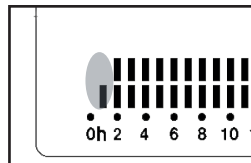

Note **single lower bar** will be displayed

OR



OR



STANDBY
button

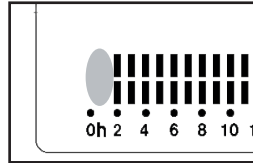

Note **no bars** will be displayed

8

To confirm your selection press the (+) button.

Repeat the mode selection process for each hour.



Note: Press the (-) button to return to the previous hour.

9

When all the bands for Monday have been programmed, press the “PROG” button to move on to the next day according to the selected type of program (**see point 3.3.1, Time Schedules**):

A

If you select **P1** program:

Repeat the previous process **for each day of the week**.

When Sunday is programmed, press the “PROG” button to confirm.

The programming mode screen will be displayed containing the updated values.

B

If you select **P2** program:

The programming module moves to the Saturday. Repeat the previous process for Saturday and Sunday.

When Sunday is programmed, press the “PROG” button to confirm.

The programming mode screen will be displayed containing the updated values.



Note: Monday to Friday every day the program is the same.



C If you select **P3** program:

Programming module press “PROG” button.

The programming mode screen will be displayed containing the updated values.



Note: Monday to Sunday every day the program is the same.



Press the “PROG” button to change between manual and programming modes.

4 “OPEN WINDOWS” FUNCTION

This radiator is equipped with open window detector.

This function can be disabled or enabled pressing the buttons “economy mode” and “anti-frost” for **3 seconds**.



Disabled function



enabled function

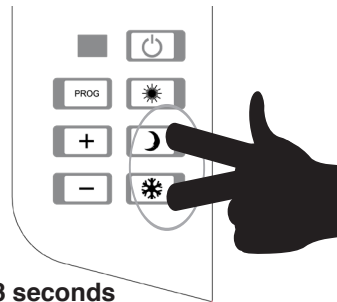

If the room temperature drops quickly, the display shows and the radiator switches to standby mode.

When the temperature stabilizes the heater will return to the normal operating state.





5 'Lock' Function

To activate the locking function, press simultaneously the buttons (+) and (-) for **three seconds**.

The  symbol is shown on the screen.

To deactivate the locking function, press simultaneously the buttons (+) and (-) for **three seconds**.

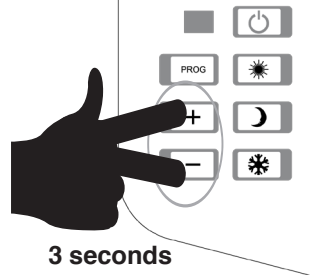

The radiator controls will automatically lock when no button has been pressed for sixty seconds.

After unlocking the keypad, the selected temperature will appear for three second with °C flashing.

The radiator controls can be unlocked, **on the remote control**, pressing the (+) **or** (-) button.

6 Power cuts

After a power cut, the radiator will switch back on automatically in the same mode as before the power cut.

All previous adjustments will remain unaltered (temperatures and custom program), **"EXCEPT THE CLOCK AND THE CURRENT DAY OF THE WEEK"**.

When the mains power has been restored, the clock and current day must be reprogrammed.

7 Maintenance

Eco radiator does not need any special maintenance.

Dust with a dry, soft cloth when the radiator is disconnected and cold.

It is best to clean the surface of the radiator at the beginning of the heating season **(always before connecting it)**.



NEVER USE SOLVENTS OR ABRASIVE PRODUCTS.



REF.	W	Nº	220V-240V ~ 50Hz CLASS I
ECO6+	600	4	
ECO9+	900	6	
ECO12+	1200	8	
ECO15+	1500	10	
ECO18+	1800	11	

ecostrad

Ecostrad Ltd.

Sanderson House
22 Station Road,
Horsforth, Leeds,
United Kingdom,
LS18 5NT

Marsan Industrial, S.A.

Avda. San Martín de Valdeiglesias, Km. 2.2
28925 Alcorcón, Madrid, Spain