

Manual de instalación y uso
Instructions & installation manual
Manuel d'installation et d'utilisation
Manual de instalação e uso

RCW



- **Mando a distancia opcional**
- **Optional remote control**
- **Télécommande en option**
- **Comando à distância opcional**



www.haverland.com
www.haverland.co.uk

Español

English

Français

Português

4	1. ADVERTENCIAS GENERALES
6	2. INSTALACIÓN
9	3. FUNCIONAMIENTO
9	3.1 PANEL DE CONTROL
10	3.2 ¡EMPECEMOS!
10	3.3 CONFIGURACIÓN HORA Y DÍA
13	3.4 ELECCIÓN MODO DE CALEFACCIÓN
14	3.5 AJUSTE TEMPERATURA CONFORT
14	3.6 AJUSTE TEMPERATURA ECONOMÍA
15	3.7 MODO ANTIHIELO
15	3.8 FUNCIÓN AHORRO “VENTANAS ABIERTAS”
16	3.9 MODO PROGRAMADO
19	3.10 BLOQUEO DE TECLADO
19	3.11 FUNCIONES AVANZADAS
21	3.12 FUNCIÓN INDICADOR CONSUMO”
23	3.13 FUNCIÓN “BABY CARE”
23	3.14 FUNCIÓN INTELIGENTE ITCS
24	3.15. DESCONEXIÓN RED ELÉCTRICA / CORTE SUMINISTRO
24	4. MANTENIMIENTO

26	1. CAUTION
28	2. INSTRUCTIONS FOR INSTALLATION
31	3. OPERATION
31	3.1 CONTROL PANEL
32	3.2 START - FIRST CONNECTION
32	3.3 SETTING THE CLOCK AND THE DAY OF THE WEEK
35	3.4 HEATING MODES
36	3.5 SETTING THE COMFORT TEMPERATURE
36	3.6 SETTING THE ECONOMY TEMPERATURE
37	3.7 ANTI-FREEZE MODE
37	3.8 “OPEN WINDOWS” FUNCTION
38	3.9 PROGRAMMING MODE
41	3.10 KEYBOARD LOCK
41	3.11 ADVANCED FUNCTIONS
43	3.12 CONSUMPTION INDICATOR FUNCTION
45	3.13 BABY CARE FUNCTION
45	3.14 INTELLIGENT ITCS FUNCTION
46	3.15 DISCONNECTION FROM THE MAINS / POWER CUT
46	4. MAINTENANCE

- **Please read these instructions carefully.**
- To disconnect mains power from the radiator remove the plug from the wall socket, but never pull on the cable.
- Do not leave the mains cable in contact with the radiator when it is switched on.
- During operation, the radiator must be kept well away from combustible materials, such as curtains, carpets and furniture etc.
- **The warranty for the radiator does not cover any damage caused by not reading these instructions.**



WARNING: In order to avoid overheating, do not cover the heater.



• **WARNING:** If the mains power cable is damaged, it must be replaced by the manufacturer, with their after-sales service or similar qualified persons, in order to prevent any danger.



• **WARNING:** If the heater is to be installed in a bathroom, it must be positioned so that it cannot be touched by anybody in the bath or shower.



• **The installation should be carried out with consideration to the manufacturer's instructions and in accordance to the relevant National Wiring Regulations BS7671.**

- It is very important that the radiator has a good Electric Earth connection.
- The radiator shall be installed so that its mains plug is always accessible.
- The radiator must not be installed below or in front of a mains socket.
- **This radiator cannot be surface-mounted with a wall. Safety distances shall always be respected.**
- **The radiator has a keyboard blockage option to prevent children from changing the programming.**
- This unit is not designed to be handled by persons (including children) with physical, sensorial or mental handicaps, or with little experience or knowledge unless they are under the supervision of an adult responsible for their safety with the instructions on its use. Children shall always be supervised to ensure they do not play with the unit.
- Children under three shall be kept well away from the heater unless they are continually supervised.
- Children between three and eight shall only switch the unit off or on providing it is positioned or installed in its final operating location and be supervised or have received instructions on how to use the unit in a safe manner and understand the risks involved.
- Children between three and eight shall not plug in, adjust or clean the heater or carry out any maintenance operations.
- This unit may be used by children older than eight and by persons with physical, sensorial or mental handicaps, with little experience or knowledge, provided they have been duly trained and are supervised by an adult that understands the risks involved.
- Cleaning and maintenance shall be performed by adults not children. Children must not play with the unit.



• **WARNING: Certain parts of this product can become very hot and cause burns.** Special attention shall be paid when children and other vulnerable persons are present.

• Do not touch the external parts of the radiator when it is operating.

• It is quite normal that, with the first switch-on, the unit produces a “new” smell. Allow your heater to operate in a well-ventilated place for two or three hours.

• Before the first switch on for the coming winter or when the heater has not been used for several days, the unit should be cleaned (follow the steps given in the “maintenance section” (page 43, point 4). This cleaning operation will avoid burning the accumulated dust and other remains.

• This radiator **CAN'T OPERATE** with external programmable controllers or any other exterior control device.



• **CAUTION:** Keep bags and other accessories well out of the reach of children.

• The convection effect, together with other ambient factors, can cause discolouring to metal surfaces and to plastics.

• Temperature differences can cause crackling and other noises in the unit. This does not indicate any failure in the radiator.

• When the radiator is disposed of, the requirements established by current legislation on waste processing and recycling shall be taken into account.

**IMPORTANT**

- It is important that the radiator **IS FIXED FIRMLY TO A SOLID AND LEVELLED WALL.**
- Make sure that there is a socket near the area where you are going to place it.
- Take out the wall pattern from the box to see the exact positions of the necessary drill holes.
- You must keep a minimum distance of 15 cm between the radiator and any object, wall or combustible material.

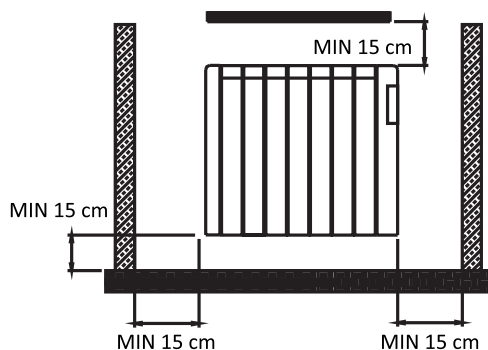

1

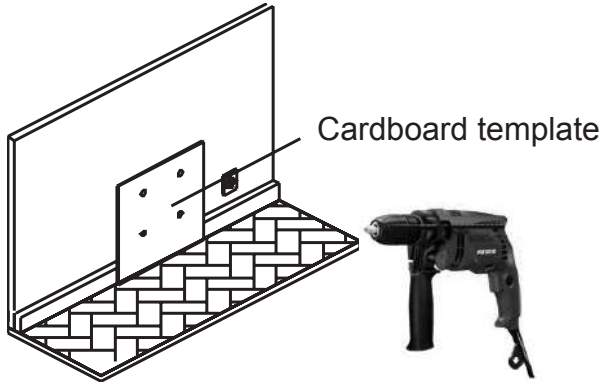

2

Place the screw
but don't
screw it fully.
(M. 6 x 40 mm)

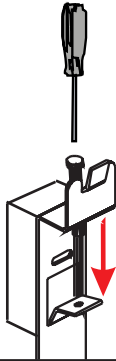

3

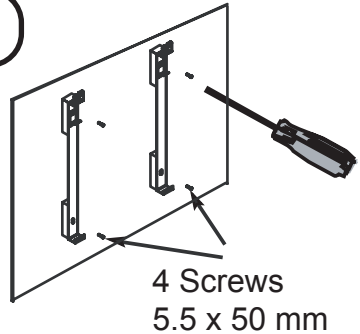

4

Place
the radiator

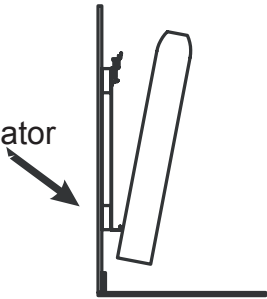

5

Slide the
radiator up,
Place over top
prong and lower
gently into
position

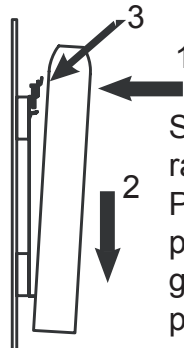

6

**IMPORTANT:**

Screw down
FULLY to lock
the radiator

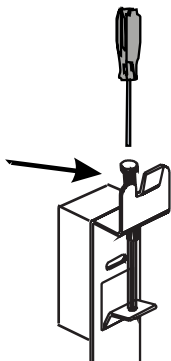
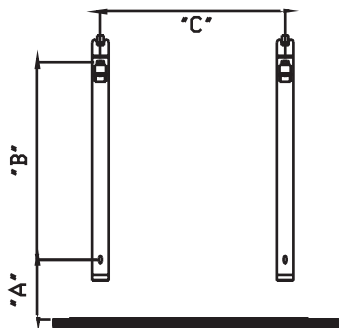
**BRACKET MOUNTING INFORMATION**

(W)	"A" (mm)	"B" (mm)	"C" (mm)
450	380	246	102,5
800	380	246	308
1100	380	246	514
1400	380	246	514
1700	380	246	719

3.1 CONTROL PANEL

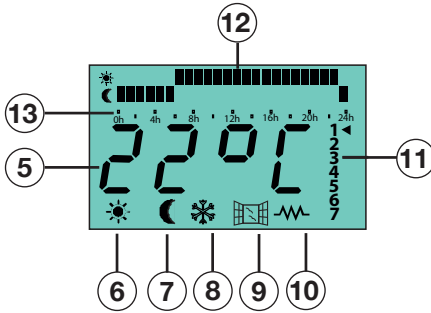

- 1. Increase
- 2. Reduce
- 3. Mode / OK
- 4. Anti-frost / Programming / Time

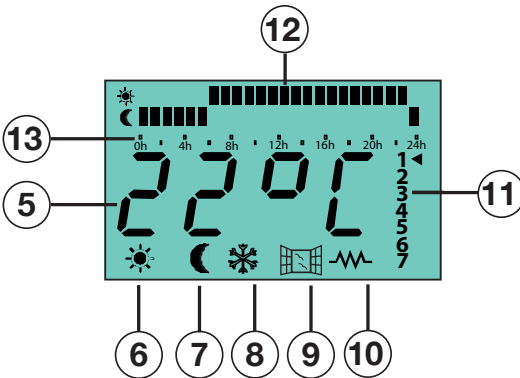

- 5. Selected temperature / Time
- 6. Comfort mode
- 7. Economy mode
- 8. Anti-frost mode
- 9. Open windows "on"
- 10. Radiator "on"
- 11. Days of the week
- 12. Programming bands
- 13. Hours

SYMBOL GUIDE

1

INDICATION OF "ACTION" (press key, etc.)

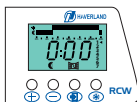

INFORMATION ON DISPLAY



IMPORTANT

3.2 START - FIRST CONNECTION

1

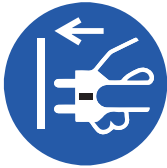

2

Press ON / OFF switch located at the right rear part of the unit.



The screen will constantly flash.

3.3 SETTING THE CLOCK AND THE DAY OF THE WEEK

1

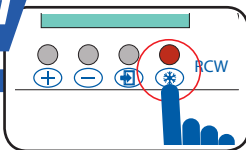

2

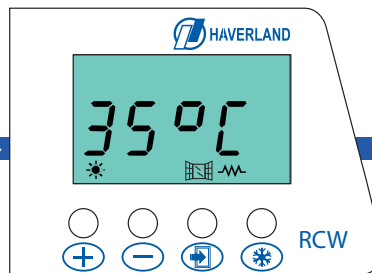
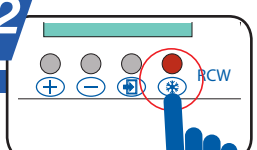

3

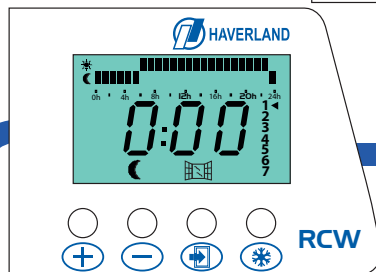
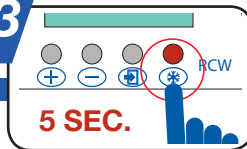

4

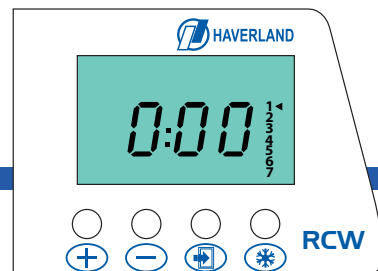
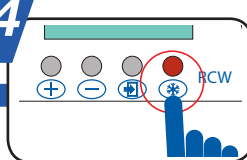

A

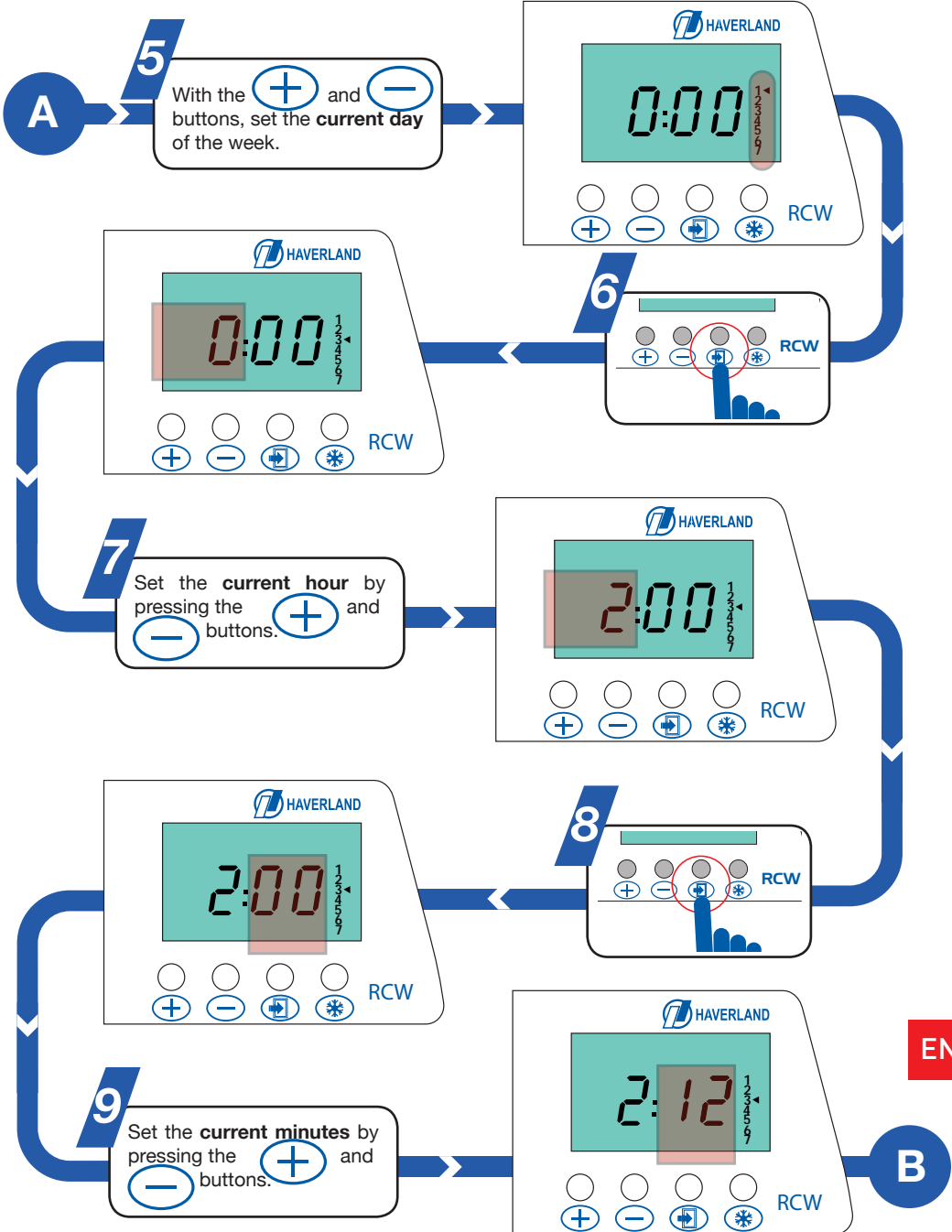

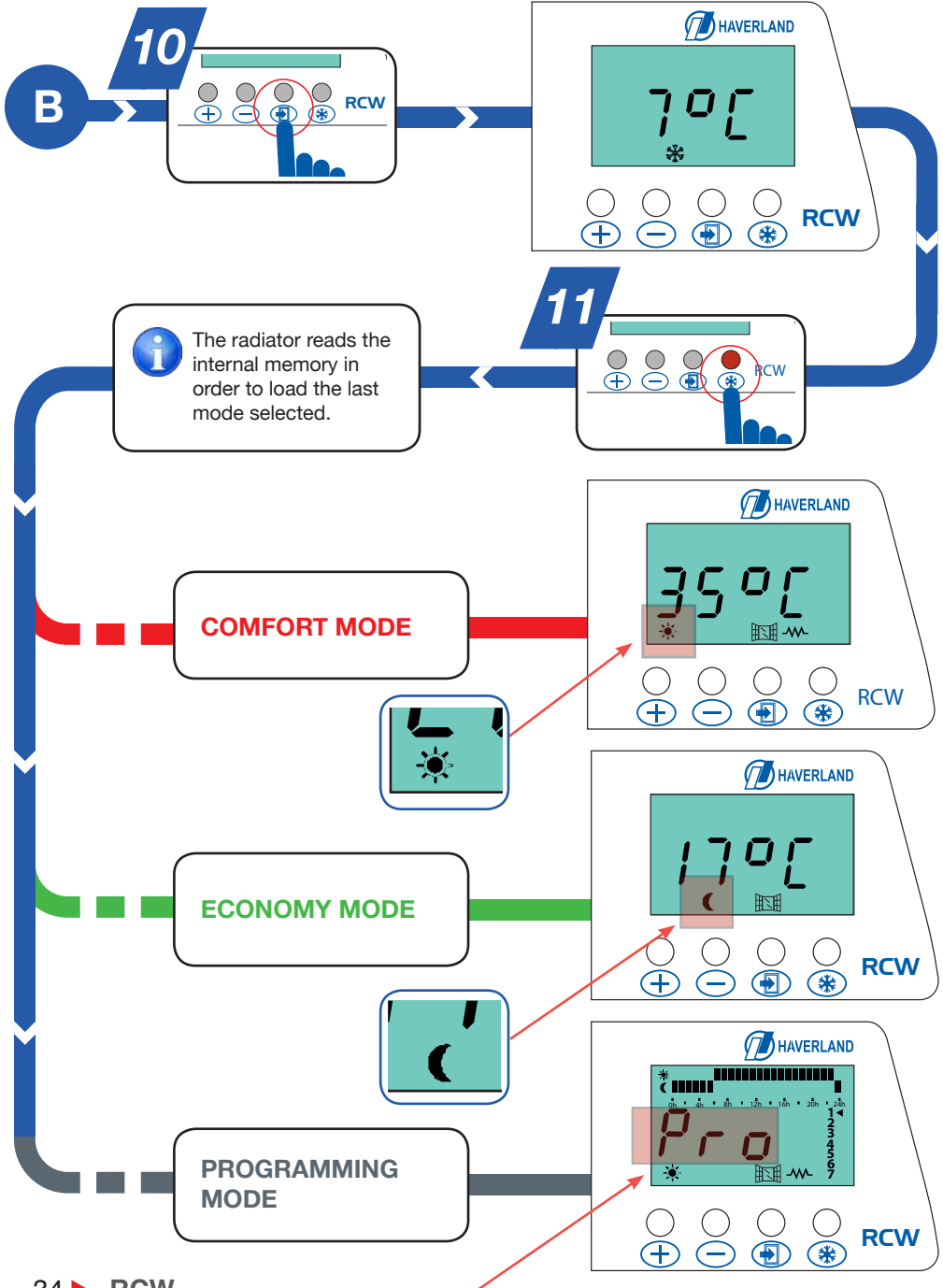

3.4 HEATING MODES

Choose the mode of operation (comfort, economy or programming mode) by pressing  button.

COMFORT MODE

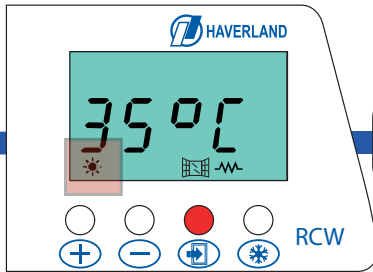

ECONOMY MODE

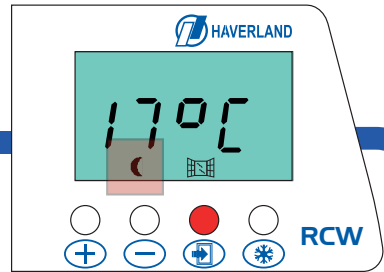

PROGRAMMING MODE

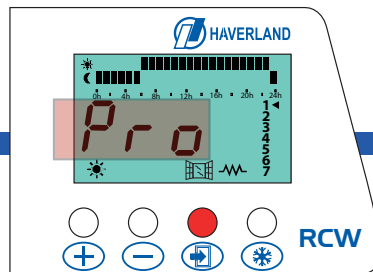

When the radiator is heating, this  symbol will be displayed.



The set temperature will be display, NOT ambient temperature.



Remember that the economy mode is the temperature that you should set when you are not in the room or overnight, and the comfort mode is the temperature that you should set in a room when you are inside it.

3.5 SETTING THE COMFORT TEMPERATURE



1

Choose the **comfort mode** by pressing  button repeatedly until the comfort symbol is displayed.

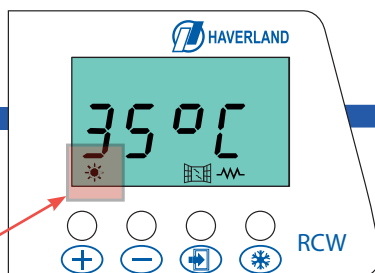
COMFORT MODE



2

This **comfort temperature** is adjusted by using the  and  buttons

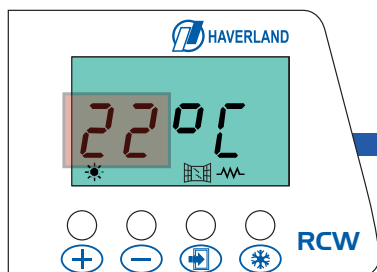

3.6 SETTING THE ECONOMY TEMPERATURE



1

Choose the **economy mode** by pressing  button repeatedly until the economy symbol is displayed.

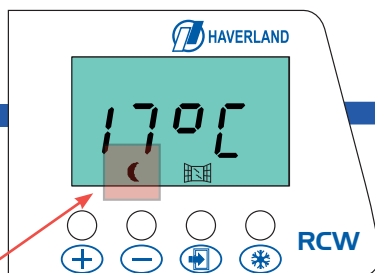
ECONOMY MODE



2

This **economy temperature** is adjusted by using the  and  buttons

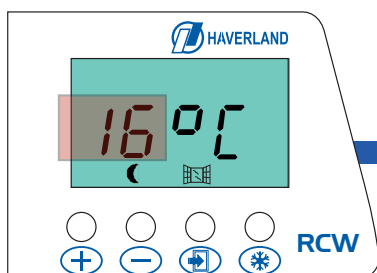

3.7 ANTI-FREEZE MODE

Thanks to this “**anti-freeze mode**”, extreme temperatures will be avoided in your home, keeping the room temperature at **7°C**.

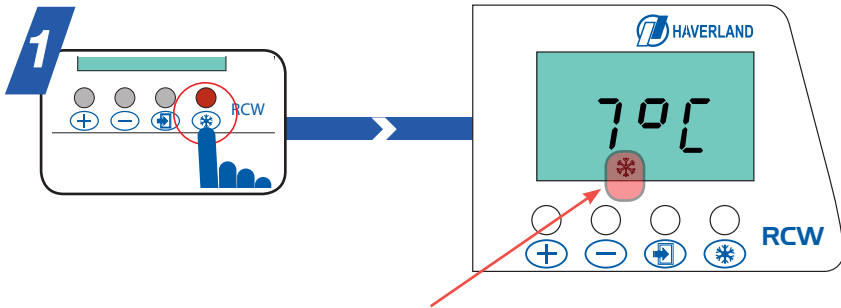

3.8 “OPEN WINDOWS” FUNCTION

This function is activated when there is a sudden drop in temperature in the room.

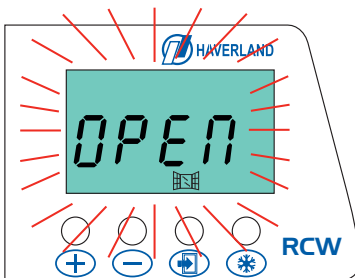

When this function activates, “**OPEN**” will appear flashing on the screen. The radiator will switch to Antifreeze mode, avoiding unnecessary energy consumption.

When the window is closed, the radiator will detect a rise in temperature and this function will deactivate.

The radiator will switch on again, returning to the state it was in before it was disconnected.



This intelligent function is factory activated. It can be deactivated by the user; see **PONT 3.11 “ADVANCED FUNCTIONS”**.

3.9 PROGRAMMING MODE

1 Choose the **programming mode** by pressing  button repeatedly until the Pro symbol is displayed.

Programming mode

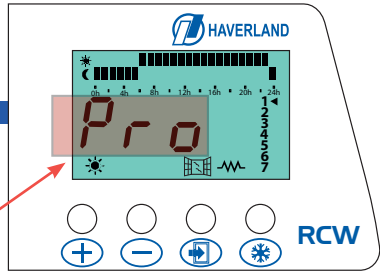

HOW DO I CREATE A HEATING PROGRAMME?

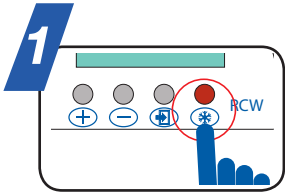

Anti-freeze

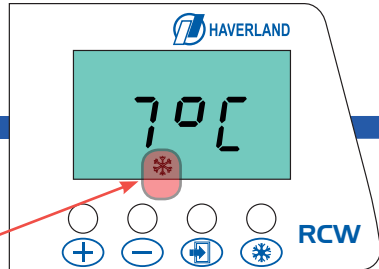

Flashing

Flashing Monday

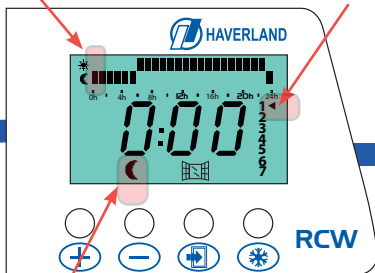

Flashing economy symbol
PROGRAMMING MENU

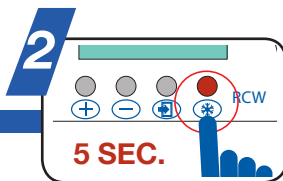

C

3

For "00:00 Monday", choose the desired function (comfort, economy or anti-freeze) by successively pressing the .

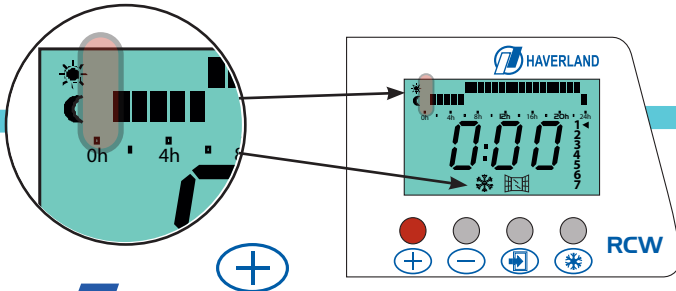
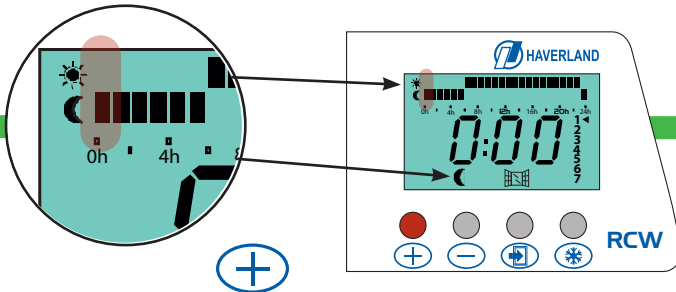
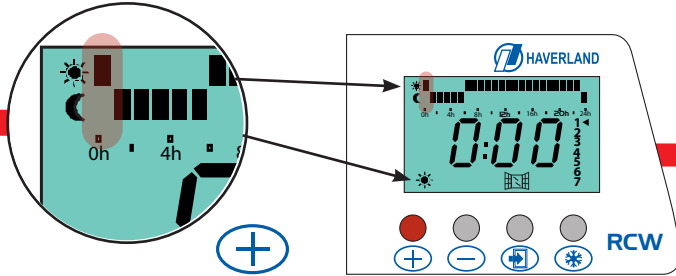

4

To confirm the selection, press the .

Repeat the above step for each hour and each day of the week.



If you press the  key, it will copy the previous operating mode over to the next hour.

D

D

5

Once you have completed the entire week, the “set hour and day” menu will automatically appear.

Follow the step **A** on page 11 if you want to adjust the day and clock, but if not, press the  key to exit the programming menu.

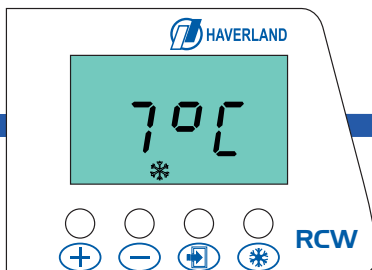
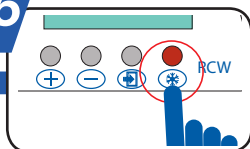

6

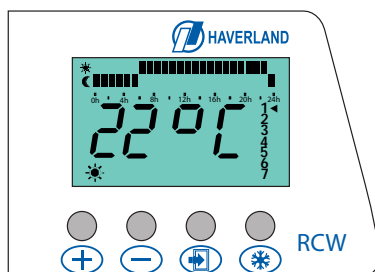
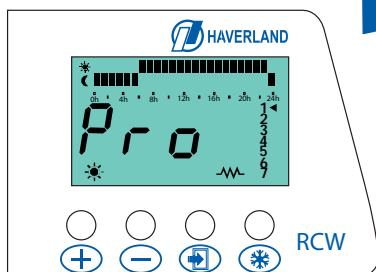

7

The word “Pro” and the temperature of the operating mode at that time will alternately show on the screen.



You can modify the temperature in comfort mode or in economy mode by pressing the  key or the  key.

The economy temperature, if not adjusted, will be at most the selected comfort temperature minus 3°C. The anti-freeze temperature is set at 7°C.

You can also modify the temperature of the comfort mode and economy mode by following points 3.5 and 3.6 on page 14.

3.10 KEYBOARD LOCK

Simultaneously press the  and  buttons until  is displayed.

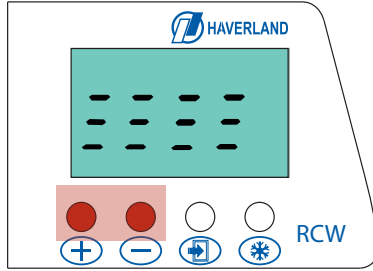

2 SEC.

The same operation must be followed to unlock the keyboard.

3.11 ADVANCED FUNCTIONS

- The “open window” function can be activated or deactivated. To access this “advanced” menu, follow these steps:

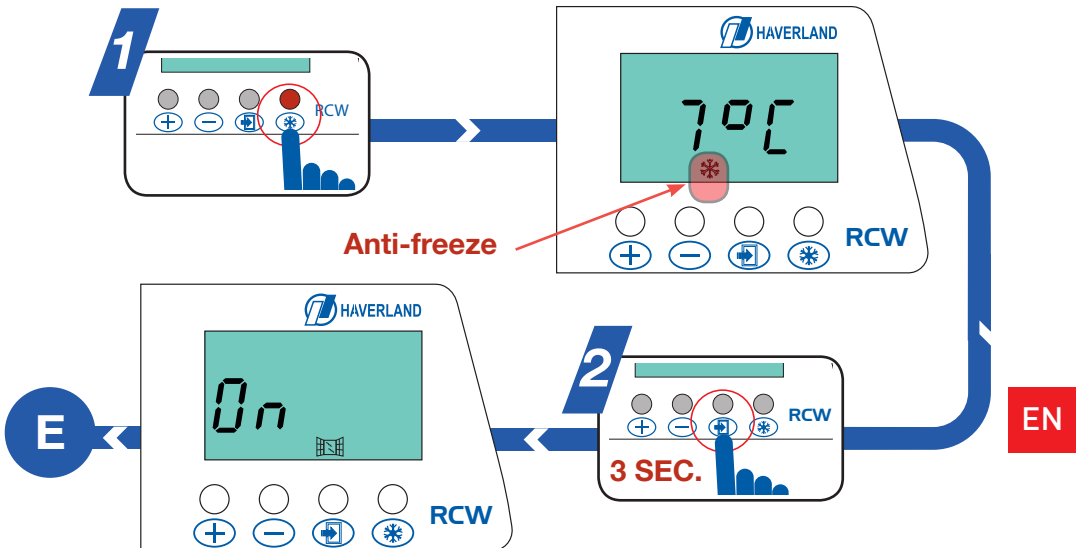

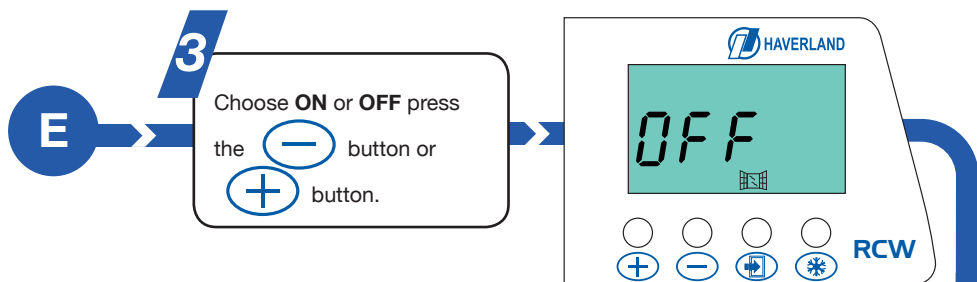

Example : OFF

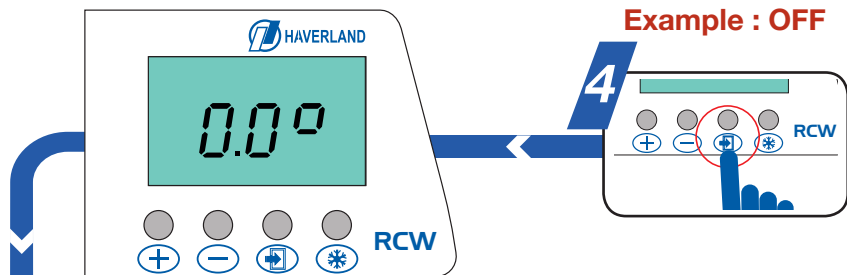

- 2** With this adjustment, **you can unify the room temperature captured by the radiator with that captured by a thermometer in the room.**

The radiator captures the temperature around 15cm from the floor and will always be different to that captured at the opposite side of the room. There may be air currents or other causes that determine these differences.

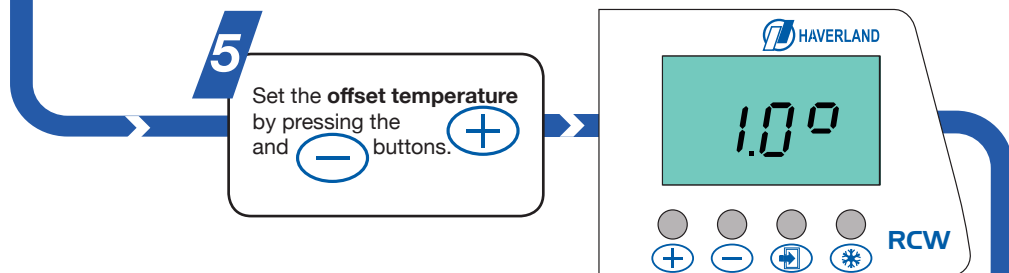

Example : offset value 1°C

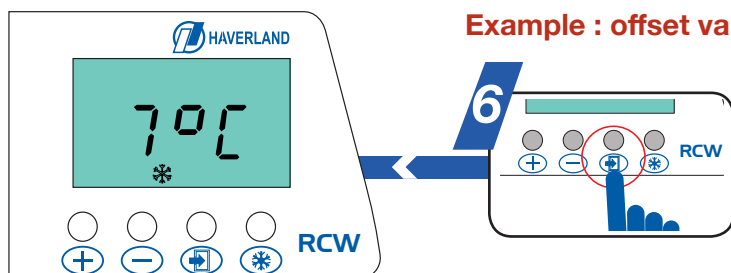

3.12 CONSUMPTION INDICATOR FUNCTION

The radiator incorporates a function that is unique on the market, which enables you to find out its electricity consumption.



We ask that you carry out the following operation to indicate the power of your radiator (this operation should only be carried out once).

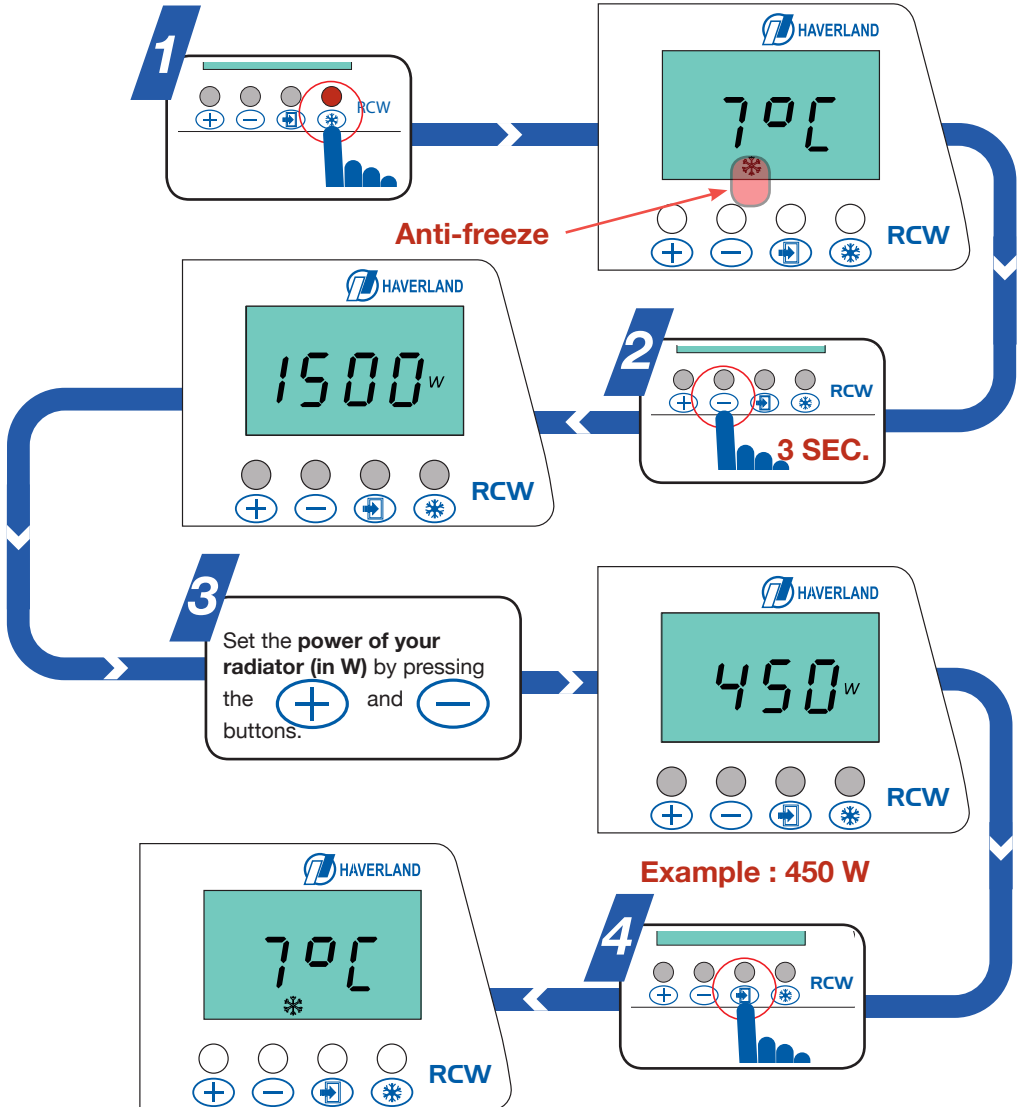

HOW DO I DISPLAY THE CONSUMPTION?

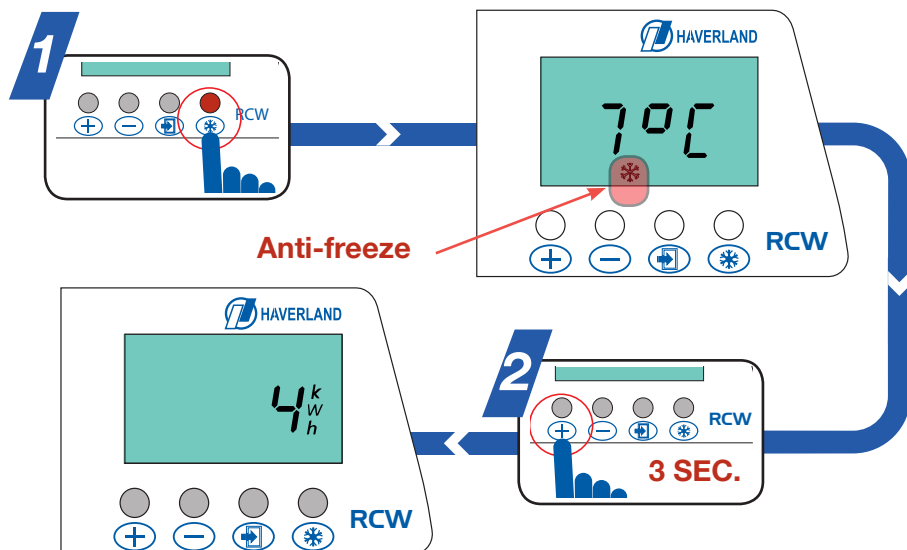



The energy meter will tell you the sum of the accumulated kWh every 24 hours up to the latest restart.

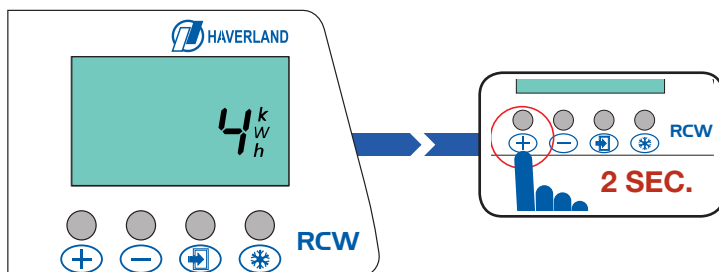

It can also be restarted at any time by pressing the **+** button for 2 seconds.

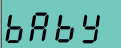

3.13 "BABY CARE" FUNCTION

Hold down  and  to activate  baby care function.

BABY CARE and ON will flash on the keypad. Repeat to de-activate. BABY CARE and OFF will display.

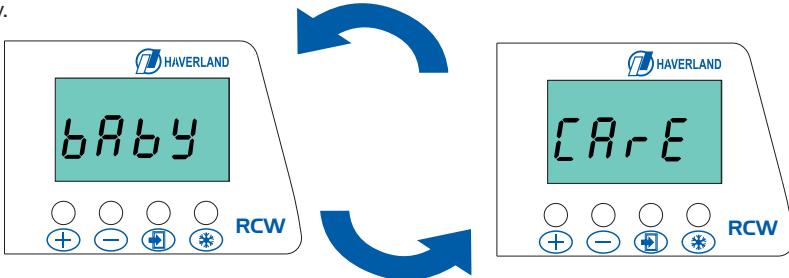

When baby care is activated, the radiator will operate approximately at half the wattage, keeping the surface at a lower temperature.



Be aware that the radiator will heat up slower and may be less effective at getting rooms to temperature when this mode is engaged.

3.14 INTELLIGENT ITCS FUNCTION

The radiator incorporates a new innovative feature, ITCS, Intelligent Temperature Control System.



This system activates the start-up of the radiator prior to the programmed time, to ensure that the desired temperature is achieved at the indicated time and following the established weekly programme.

This intelligent function is factory set. It can be deactivated by the user.

In order to deactivate it the radiator must be on Anti-freeze mode. To set the Anti-freeze mode press the  button.

Press and hold 3 seconds the  button to access this function menu.

Next, press the  button until the "sun" and "moon" are displayed.

Press the  or  buttons to choose ON to activate or OFF to deactivate the function and press  to confirm.



ITCS operates with the programming mode. When the function is activated the "sun" icon will start flashing alternately with "PRO".



3.15 DISCONNECTION FROM THE MAINS/POWER CUT

If there is a disconnection from the mains, if you disconnect the radiator from the on/off switch or there's a power cut that lasts more than 4 hours, you must re-set the day and time.

Set the day and time again by following point 3.3 on this manual (SETTING THE CLOCK AND THE DAY OF THE WEEK).

If the electricity disconnection or power cut supply lasts **less than 4 hours**, all parameters will be maintained. It will even remember the last operating modes and chosen comfort and economy temperatures.

4. MAINTENANCE

Your radiator does not need any kind of special maintenance.

Just remove any dust with a soft dry cloth.

We recommend starting the winter season by cleaning off the dust that has built up on the heater surface.



NEVER USE SOLVENTS OR ABRASIVE PRODUCTS.



Where you see this symbol on any of our electrical products or packaging, it indicates that the relevant electrical product should not be disposed of as general household waste in Europe. To ensure the correct waste treatment of the product, please dispose of it in accordance with any applicable local laws or requirements for disposal of electrical equipment. In so doing, you will help to conserve natural resources and improve standards of environmental protection in treatment and disposal of electrical waste.

GUARANTEE

MARSAN INDUSTRIAL, S.A. guarantees that the devices comply with the contracted specifications.

This warranty only covers the model of heater shown on the valid invoice.

Such rectifications will be guaranteed against any manufacturing and operating defect for the normal and domestic use of this product, for a period of 24 months as from the purchase date shown on the invoice.

HAVERLAND guarantees against material, design or manufacturing faults at the moment of its original acquisition for 2 years. The electronic component for 3 years (exclude accidental damage, transport, and misuse).

This warranty only covers the device whose model appears on the purchase invoice.

This warranty DOES NOT COVER incorrect installation, maintenance, cleaning or conserving the device, and neither does it cover failures and faults due to force majeure, chemical agents or atmospheric phenomena, incorrect use of the device, the purchaser's faulty electrical installations, transporting the device or problems caused by the device being handled by persons not authorised by MARSAN INDUSTRIAL, S.A.

This warranty must not be modified, altered or extended, and the Manufacturer does not authorise anybody to act on his behalf to modify, alter or extend it.

This warranty applies only to the Product.

To repair the device, the consumer must dial the Technical Assistance Service at 0330 3651940 or send an email to haverland@haverland.co.uk and ask for the information needed about the procedure to follow:

For a replacement, cancellation or price reduction, when in order, the consumer must go to the establishment where the device was purchased. This warranty does not affect the consumers' rights as established in the provisions contained In Ley 23/2003, the Consumer Goods Sales Guarantee Act.



Customer Service Telephone:
0330 3651940



E-mail: haverland@haverland.co.uk

Haverland UK Limited
Challengue House
Sherwood Drive
Bletchley MK3 6DP

Made in Spain

Marsan Industrial, S.A. reserves the right to modify without previous warning

Modelos / Models / <i>Modèles / Modelos</i>	RC3W	RC5W	RC7W	RC9W	RC11W
Potencia calorífica / Heat output / <i>Puissance thermique / Potência calorífica</i>					
Potencia calorífica nominal (kW) Nominal heat output (kW) <i>Puissance thermique nominale (kW)</i> <i>Potência calorífica nominal (kW)</i>	0.45	0.8	1.1	1.4	1.7
Potencia calorífica máxima continuada (kW) Maximum continuous heat output (kW) <i>Puissance thermique maximale continue (kW)</i> <i>Potência calorífica continua máxima (kW)</i>	0.45	0.8	1.1	1.4	1.7
Consumo auxiliar de electricidad / Auxiliary electricity consumption / <i>Consommation d'électricité auxiliaire / Consumo de eletricidade auxiliar</i>					
A potencia calorífica nominal (kW) At nominal heat output (kW) <i>À la puissance thermique nominale (kW)</i> <i>À potência calorífica nominal (kW)</i>	0.45	0.8	1.1	1.4	1.7
A potencia calorífica mínima (kW) At minimum heat output (kW) <i>À la puissance thermique minimale (kW)</i> <i>À potência calorífica mínima (kW)</i>	0.45	0.8	1.1	1.4	1.7
En modo de espera (kW) In standby mode (kW) <i>En mode veille (kW)</i> <i>Em estado de vigília (kW)</i>	N.A.	N.A.	N.A.	N.A.	N.A.
Tipo de control de temperatura interior Type of heat room temperature control <i>Type de contrôle de la température de la pièce</i> <i> Tipo de comando da temperatura interior</i>	Con control electrónico de temperatura interior y temporizador semanal Electronic room temperature control plus week timer <i>Contrôle électronique de la température de la pièce et programmeur hebdomadaire</i> <i> Com comando eletrônico da temperatura interior e temporizador semanal</i>				
Otras opciones de control	- Control de temperatura interior con detección de ventanas abiertas - Con opción de control a distancia				
Other control options	- Room temperature control, with open window detection - With distance control option				
Autres options de contrôle	- <i>Contrôle de la température de la pièce, avec détecteur de fenêtre ouverte</i> - <i>Option contrôle à distance</i>				
<i>Outras opções de comando</i>	- <i>Comando da temperatura interior, com deteção de janelas abertas</i> - <i>Com opção de comando à distancia</i>				
Nombre del fabricante / Name del fabricante / <i>Nom du fabricant / Nome do fabricante</i>	Marsan Industrial, S.A.				
Dirección / Address / <i>Adresse / Endereço</i>	Avda. San Martín de Valdeiglesias, Km 2.2 28925 Alcorcón (Madrid) España / Spain / <i>Espagne / Espanha</i>				

RCW

	W	Nº 
RC3W	450	3
RC5W	800	5
RC7W	1100	7
RC9W	1400	9
RC11W	1700	11

230 V 50 Hz

CLASE I
CLASS I
CLASSE I