

# ecostrad

INSTRUCTION MANUAL

## Ecostrad Digital Heating Element



PLEASE READ AND SAVE THESE INSTRUCTIONS



# Symbols



## Warning

This symbol indicates a hazard with an average risk level which, if not avoided, could result in serious injury or death.



## Warning of electrical voltage

This symbol indicates danger to the life and health of persons due to electrical voltage.



## Hot surface

This symbol located on the device indicates that its surfaces are hot during and immediately after operation. Hot surfaces should not be touched: danger of burns.



## Do not cover

This symbol indicates that it is prohibited to hang objects (such as towels, clothes etc.) on the device such that the electric components could become covered. To avoid overheating and fire hazards, ensure the electric components are never covered.



## Observe instructions in manual

This symbol located on the device indicates that instructions in the operating manual must be observed when installing and using the device.

# 1 | Contents

<b>1  </b>	<b>About the Manual</b>	<b>3</b>
<b>2  </b>	<b>Technical Information</b>	<b>3</b>
<b>3  </b>	<b>Warnings &amp; Precautions</b>	<b>4</b>
<b>4  </b>	<b>Installation</b>	<b>8</b>
4-1	Fitting instructions	9
<b>5  </b>	<b>Control Dial</b>	<b>13</b>
5-1	Display	13
5-2	First power on	13
5-3	Standby mode	14
5-4	Heating mode	14
5-5	Timer mode	14
<b>6  </b>	<b>Troubleshooting</b>	<b>16</b>
<b>7  </b>	<b>Warranty</b>	<b>17</b>
<b>8  </b>	<b>Disposal</b>	<b>19</b>

### 1 | About the Manual

This manual describes the Ecostrad Digital Heating Element and details how to install and use the product. It is important to thoroughly review this manual before using the product.

The declaration of conformity is issued under the sole responsibility of the manufacturer.

For **technical advice** or help concerning the Ecostrad Digital Heating Element, contact the retail establishment or distributor from which the product was purchased

### 2 | Technical Information

**Table 1 | Specifications**

Voltage	230V AC / 50Hz
Wattage	200-600W
Room temperature setting	10-35 °C
IP Rating	IP44
Appliance class	Class I
Power cable length	1.5m
Thread size	G ½ "
Certification	<p>These products are in compliance with 2014/30/EU Electromagnetic Compatibility Directive and 014/35/EU Low Voltage Directive.</p> <p>These products carry CE mark accordingly.</p>

### 3 | Warnings & Precautions

#### READ ALL SAFETY WARNINGS AND ALL INSTRUCTIONS.



Read this manual carefully before using or installing the heating element. Always store the manual in the immediate vicinity of the radiator or its site of use.

Failure to follow the warnings and instructions may result in electric shock, fire, serious injury, or all of the above. Save all warnings and instructions for future reference.

**NOTE** - This element cannot be used as part of a central heating system or in a dual source towel rail. The electric towel rail must be powered by the heating element only.

#### Warning



Children of less than 3 years should be kept away unless continuously supervised. Children aged from 3 years and less than 8 years shall only switch on/off the appliance provided that it has been placed or installed in its intended normal operating position and they have been given supervision or instruction concerning use of the appliance in a safe way and understand the hazards involved. Children aged from 3 years and less than 8 years shall not plug in, regulate, or clean the appliance, or perform maintenance.

#### Warning



In order to avoid a hazard due to inadvertent re-setting of the thermal cut-out, this appliance must not be supplied through an external switching device, such as a timer, or connected to a circuit that is regularly switched on and off by the utility.

## Warnings & Precautions

### Warning



Some parts of this product can become very hot and cause burns. Do not touch the surface when in operation. Do not install close to curtains or other combustible materials. Particular attention should be given where children and vulnerable adults are present.

### Warning



Do not use the device in enclosed spaces if persons are present who cannot leave the room independently and are not under constant supervision.

- Fluid-filled towel rails for space heating and towel drying are the only suitable appliances in which to install the element.
- The element must NEVER be used unless it has been professionally installed inside a towel rail filled with fluid to the correct level. The element will cease functioning within 5 seconds if it is not fully submerged in a suitable fluid during operation.
- The element is designed for use in vertical towel rails. Use in horizontal towel rails is not recommended because the long horizontal bars can impede heat circulation.
- It is imperative that the towel rail intended for use with the heating element has the correct volume of fluid. The recommend quantity of fluid with the towel rail is 90% of the unit's total volume. If you are installing the element in towel rail that has been pre-filled for use with this element, do not allow fluid to escape when the element is fitted. In the case of loss of heating fluid, contact your supplier.
- This device is intended for home use only.
- The element must be installed by a licensed electrician in accordance with current IEE wiring regulations.
- The element must be connected to a 220-240 Volt AC mains power supply via a switched fused spur cable outlet, and must be earthed.

## Warnings & Precautions

- The element is a Class I unit and therefore must always be earthed.
- Ensure the element's power cord does not touch the hot parts of the device or the towel rail.
- Do not use the device if you detect damage to the mains plug or power cable. If the supply cord is damaged, it must be replaced by the manufacturer, its service agent or similarly qualified persons to avoid a hazard. All repairs and servicing must be carried out by a qualified person.
- The towel rail in which the element is installed must be permanently fixed to the wall. Do not fit the towel rail below or in front of an electric socket.
- The element can be installed in bathrooms in Zone 2, but never in Zone 0 or Zone 1, as defined by applicable law, subject to any additional regulations concerning electrical installations in wet areas, as shown in **Figure 1**.

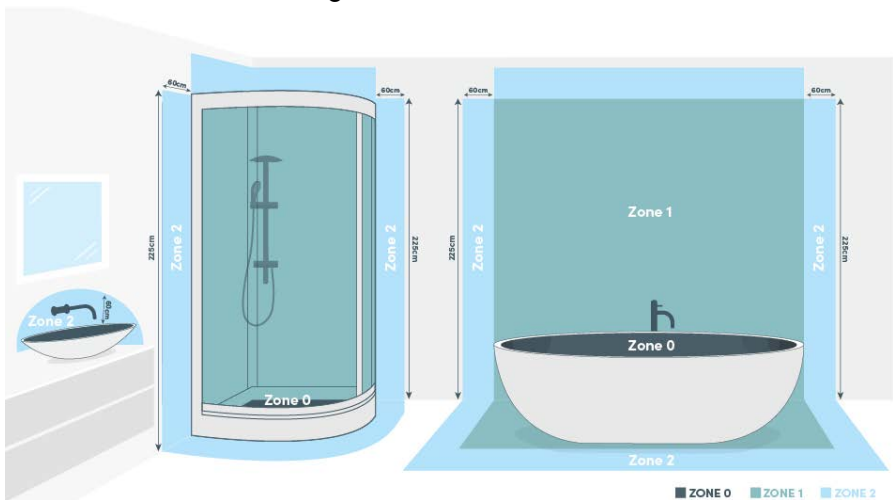

Figure 1 | Bathroom installation zones

- The element must be placed where the switches and controllers cannot be touched by a person in a bathtub or shower.
- The element must be disconnected from the mains during cleaning and maintenance.

## Warnings & Precautions

- Never attempt to disconnect the control head from the heating element. The product is an integrated unit that has been factory sealed.
- Do not open the casing of the element – any interference with internal components will invalidate the warranty.
- Towel rails fitted with the element can be very hot and can cause burns. Pay special attention when used in the presence of children or people with disabilities.
- If the towel rail is used to dry clothing or towels, ensure the fabrics have only been washed in water, to prevent the device coming into contact with harsh chemicals.
- Do not allow children to play with the element. This appliance is not a toy.
- The unit is not to be used by persons (including children) with reduced physical, sensory or mental capabilities. Such persons may only use the device if they are supervised by a responsible person.
- For the safety of very small children, install the towel rail so that the lowest rail is at least 60cm above the floor.
- Ensure the heating element control head is not exposed to leaking water.



### 4 | Installation

These are general-purpose instructions for fitting your element into a suitable towel rail. Always check with the towel rail manufacturer to ensure the product is suitable for use with the element, and follow any additional installation guidance provided with the unit. Installation must be completed by a qualified electrician. Do not attempt installation DIY.

#### Warning



Do not attempt to operate the element before it has been installed in a fluid-filled towel rail. Switching on the element in an empty towel rail or in open air will cause the element to cease functioning.

#### Warning



Do not attempt to install the heating element whilst it is connected to electricity. Disconnect device from mains prior to installation.

#### Warning



Please take every precaution when filling the towel rail or fitting the element in order to avoid being burnt by hot liquid.

#### Warning



Remove the protective coating on the plastic enclosure before use.

## 4-1 | Fitting instructions

If you have purchased a pre-filled towel rail with the element already installed, skip to step 7 below.



1. Read all safety instructions and warnings stated in the preceding section of this manual. Failing to follow these instructions can cause damage to life or property.
2. Identify the inlet where the element will be fitted in the towel rail. The element is fitted vertically, in the bottom left or right vertical strut. Never fit the element at the top of a towel rail or in horizontal towel rails (**Figure 2**).

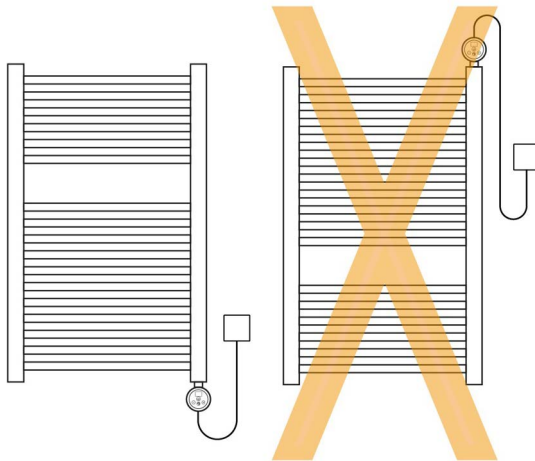

Figure 2 | Correct and incorrect installation positions of the element

## Installation

3. Tilt the towel rail until the fitting location is at the highest point, as shown in **Figure 3**. This prevents any fluid escaping if your towel rail is pre-filled.

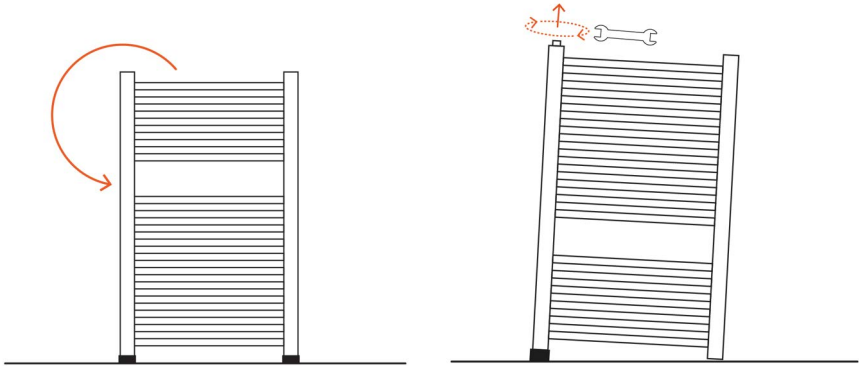

Figure 3 | Inlet tilted to its highest point before opening..

4. Slowly, so as not to displace any fluid, remove the cap from the inlet and push the heating element into the towel rail.
5. Tighten the element at the main nut, using a size 26 spanner (**Figure 4**).

Ensure the connection between the towel rail and the heating element is tight and there is a firm seal. This prevents leakage after installation.

**WARNING** – Never attempt to tighten the element by twisting the control head or product housing by hand. Always use the correct tools as directed in the instructions.

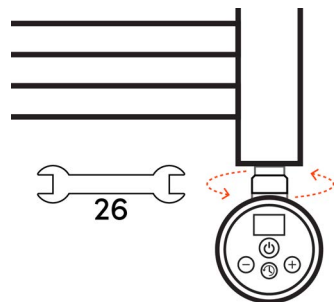

Figure 4 | Tighten element at main nut

## Installation

6. If the towel rail has been pre-filled by the manufacturer, skip to the next step. Do not tamper with the heating medium in pre-filled towel rails.
7. If the towel rail is yet to be filled, tilt the towel rail so the next free filling point is at the highest point.
8. Ensure the towel rail is not resting on the heating element controller, power cable or any other parts of the connection.
9. Remove the cap and fill the towel rail to 90% of its volume with a suitable heating medium (**Figure 5, Figure 6**). This should be a glycol-based formulation approved by the towel rail manufacturer. Replace cap when done.

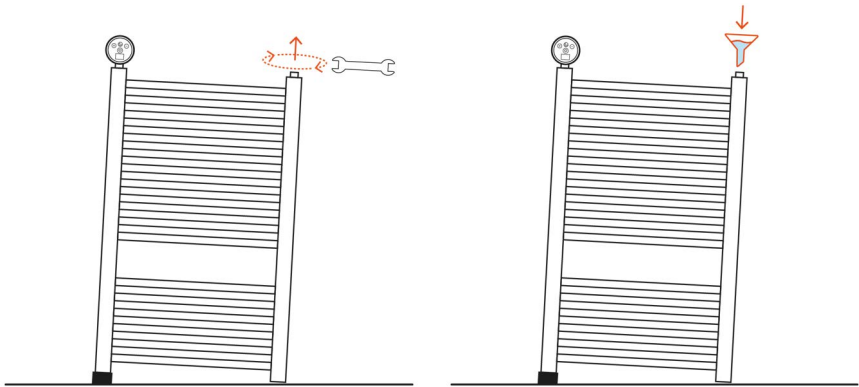

Figure 5 | Removing towel rail cap and using funnel to fill

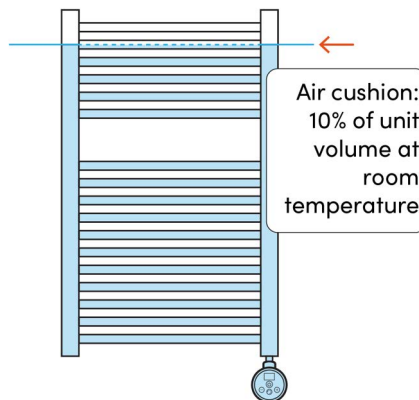

Figure 6 | Air cushion requirement (image for illustrative purposes only)

## Installation

### WARNING

It is critical that the correct volume of heating medium is used. Under-filling the radiator will impede circulation and prevent the unit from heating up. Overfilling the radiator can cause a dangerous build up of pressure as the fluid heats up. A suitable air cushion must be maintained. Calculating the volume of heating medium is a job for a professional electrician or heating engineer and should not be attempted DIY. If unsure, use the element only with a pre-filled radiator.

10. Rotate the towel rail to its correct orientation and hang on the wall, according to the instructions provided with the unit.
11. Connect the element electrics to the power supply. The element should be hardwired to a switched fused spur. This is a task for a qualified electrician and should not be attempted DIY. Risk of electric shock.



## 5 | Control Dial

### 5-1 | Display

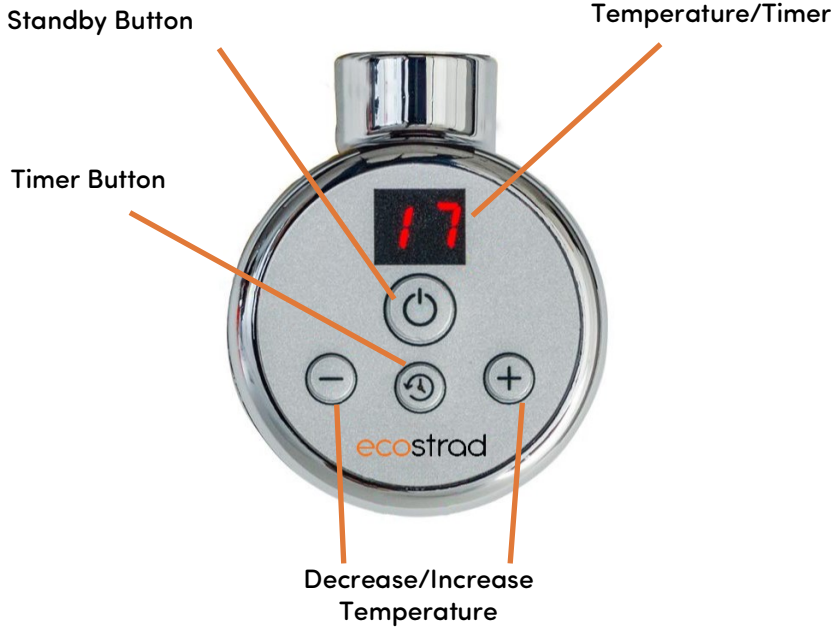



Figure 7 | Control dial display

### 5-2 | First power on

When the Digital is first turned on after being disconnected from the mains, the screen will show a countdown from 3 before entering standby mode.

### 5-3 | Standby mode

Press  to switch between standby and heating mode



In standby mode the element does not heat.

Use  to switch between standby and on.



When the element is in standby, the screen will show "--".



### 5-4 | Heating mode

Use  and  to decrease or increase the temperature between 10 and 35 °C.

Press  button to switch the element on. The element will show the set temperature. After a few seconds the element will switch to showing the current room temperature.

Use  and  to decrease and increase the set temperature between 10 and 35 °C. After the set temperature is selected, the element will again resume showing the current room temperature. If the room temperature is lower than the set temperature, the element will begin heating.

### 5-5 | Timer mode

The timer range is from 0 to 5 hours in steps of 1 hour



When the timer is set, the element will heat to the set room temperature for the time period selected. When the period ends, the element will switch to standby mode and cease heating.

When the timer is running, the element displays a small flashing light between the numbers of the room temperature.



## Control Dial

### Setting the timer:

1. Press . The display will show the number of set hours for the timer.
2. Press  to increase the timer period from 1 to 5 hours.

To cancel the timer, press  until the display shows "0". The element will resume heating to the set temperature indefinitely.





## 6 | Troubleshooting

Error Code	Possible Cause	Action to take
E01	<p>This might be caused by:</p> <ul style="list-style-type: none"> <li>• Heating sensor cable might be disconnected.</li> <li>• Heating probe might be damaged.</li> <li>• Heating element might be damaged.</li> </ul>	<p>The product should be reset. Cut power to the device then restore.</p> <p>If the fault continues, disconnect the product and contact Ecostrad by the contact details in section 1</p>
E02	<p>This code shows that the device has detected an overheat state and has cut power. This might be because:</p> <ul style="list-style-type: none"> <li>• Electronic control unit might be damaged.</li> <li>• Heating element might be damaged.</li> <li>• Voltage change in the electric supply system might have affected the unit.</li> </ul>	<p>The product should be reset. Cut power to the device then restore.</p> <p>If the fault continues disconnect the product and contact Ecostrad by the contact details in section 1.</p>

### 7 | Warranty

The Ecostrad Digital element carries a 2-year guarantee.

#### **What does the warranty cover?**

Within the stated period, starting from the date the customer receives their unit, Ecostrad guarantee to repair or replace the unit where a fault is due to defects in materials or manufacturing.

#### **What does the warranty NOT cover?**

The warranty does not cover any defect arising from damage, negligence, usage outside the product's intended purpose or fair wear and tear. The warranty is only valid when the unit has been used at the specified supply voltage, and in accordance with all conditions specified in this manual. The warranty will be void if the element has been tampered with or opened in any way; if it has been used in open air, or in an unsuitable vessel; or if the ratings label has been removed.

The warranty does not cover failures and faults due to force majeure, accidental damage, mishandling, external impact, chemical agents or atmospheric phenomena, incorrect use of the device, the purchaser's faulty electrical installations, transporting the device or problems caused by the device being handled by persons not authorised by Ecostrad. The element is not a DIY product; an invoice may be required to confirm installation was carried out by a qualified professional. Ecostrad cannot accept responsibility for damage, loss or injury caused by incorrect installation, maintenance, cleaning or covering the device.

## Warranty

### How to claim

The warranty is a contract with the original purchaser and does not transfer if the unit is re-sold, gifted or inherited. Proof of purchase, including order number and order confirmation or invoice, will be required if a claim is made.

The warranty covers only the model shown on the purchase invoice. The warranty covers the repair or replacement of the defective product only and Ecostrad shall have no liability for installation costs or consequential losses however incurred. Claims must be made with the establishment where the device was purchased. This warranty does not affect the customer's consumer rights.

### 8 | Disposal



In accordance with WEEE Directive 2012/19/EU, the icon with the crossed-out waste bin on electrical or electronic equipment stipulates that this equipment must not be disposed of with household waste at the end of its life. You will find collection points for free return of waste electrical and electronic equipment in your vicinity. The addresses can be obtained from

your local authority.

The separate collection of waste electrical and electronic equipment enables the re-use, recycling and other forms of recovery of waste equipment, and prevents any negative effects for the environment or human health caused by the disposal of hazardous substances potentially contained in the equipment.

For queries, contact:

#### **The UK manufacturer**

Ecostrad Ltd.  
Unit 21 Ash Way  
Avenue C  
Thorp Arch Trading Estate  
WETHERBY  
West Yorkshire  
LS23 7FR

#### **The ROI importer**

Ignition Heatco Ireland Limited  
Unit 282  
Block G  
Blanchardstown Corporate Park 2  
Dublin  
Republic of Ireland  
D15 R65X

<https://ecostrad.com>